

W28 series

Switchable or Push to Reset Fuseholder-Type Thermal Circuit Breaker

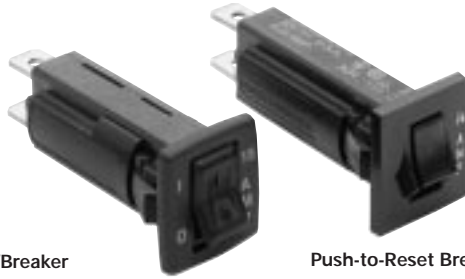

Switch/Breaker

Push-to-Reset Breaker



Note: VDE not available on 16A and 20A W28

Users should thoroughly review the technical data before selecting a product part number. It is recommended that users also seek out the pertinent approvals files of the agencies/laboratories and review them to ensure a product meets the requirements for a given application.

Features

- Switchable version combines on-off switch and circuit protection in a single unit.
- Approved to many international standards (push to reset type).
- Replaces SLOW-BLOW glass cartridge fuse.
- Labor-saving snap-in mounting.
- Button extends for visual trip indication on push to reset model.
- Rocker on switchable model moves to "overload" position upon trip.

Agency Approvals

W28-X series is UL 1077 Recognized as Supplementary Protectors, File E69543, and CSA Certified as Appliance Component Protectors, File LR15734. W28-X breakers (up through 15 amps) are VDE approved for use in office equipment and provide 8mm isolation.

W28-S is UL 1077 Recognized, and CSA Certified for models up to and including 15 amps.

Resettable Overload Capacity: Six times rated current for 0.25 through 2 amp models. Ten times rated current for 3 through 20 amp models.

Reset Time: 180 seconds max. for 0.25 through 2 amp models. 10 to 60 seconds for 3 through 20 amp models.

Typical Resistance vs. Current Rating @ +25° C

Current Rating in Amps	Typical Resistance in Ohms	Current Rating in Amps	Typical Resistance in Ohms
0.25	14.0	8.0	0.016
0.50	3.55	9.0	0.014
0.75	2.0	10.0	0.011
1.0	0.89	11.0	0.01
2.0	0.17	12.0	0.009
3.0	0.069	13.0	0.009
4.0	0.043	14.0	0.007
5.0	0.030	15.0	0.007
6.0	0.026	16.0	0.007
7.0	0.017	20.0	0.006

Electrical Data @ 25°C

Calibration: Will continuously carry 100% of rating.
 3-20 amp models – may trip between 101% and 134%, but must trip at 135% of rating within one hour at +25°C.
 0.25-2 amp models – may trip between 101% and 174%, but must trip at 175% of rating within one hour at +25°C.

Dielectric Strength: Over 1,500 volts RMS.
Maximum Operating Voltages: 32VDC; 250VAC, 50/60 Hz.
Interrupt Capacity: 1,000 amps at 250VAC, 50/60 Hz, and 32VDC in accordance with UL standard 1077.

Mechanical/Environmental Data

Endurance Cycling (switchable type): > 6,000 cycles at 100% of rating or 10,000 mechanical cycles.
Termination: .250" (6.35mm) quick connects. Soldering to terminals is not recommended.
Mounting: Snaps into panel from front. See Recommended Panel Cutouts.
Approximate Weight: 0.35 oz. (10g).

Time vs. Current Trip Curve @ +25°C

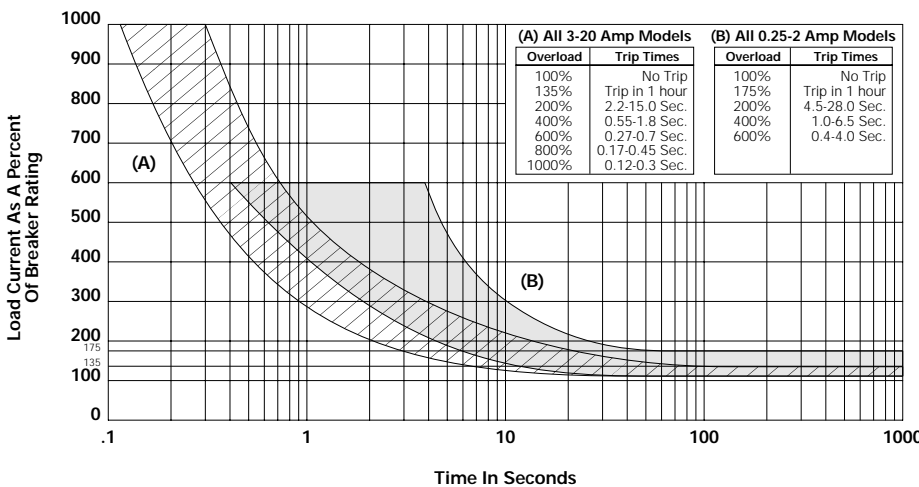

Ambient Compensation Chart

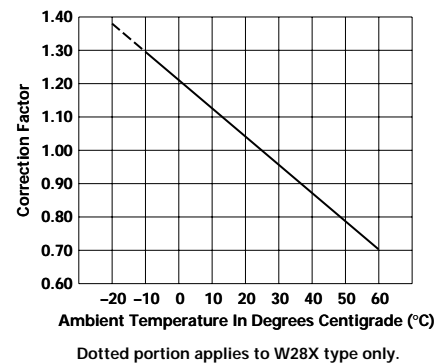

To use this chart: Read up from the ambient temperature to the curve, and across to find a correction factor. Multiply the breaker rating by the correction factor to determine the compensated rating. Calculate the overloads in terms of the compensated rating to use the published trip curve. Do not use these devices outside their specified operating temperature ranges.

Ordering Information

Typical Part Number ▶

W 28 -X Q 1 A -5

1. Designator:

W = Circuit breaker

2. Series Number:

28 = Single Pole Fuseholder Type

3. Circuit Function:

X = Series Trip, Push-to-Reset Button S = Series Trip, Switchable Rocker

4. Terminal Type and Mounting:

Q = .250" (6.35mm) Quick Connect will mount in .032"-.062" (.813mm - 1.574mm) thick panel.
 T = .250" (6.35mm) Quick Connect will mount in .075"-.105" (1.905mm - 2.667mm) thick panel.
 For panel thicknesses other than above, order "Q" type and 55-025B Internal Tooth Push-On Lockwasher.

5. Bezel Color:

1 = Black with White Rate Marking † 11 = Black with No Rate Marking
 2 = Red with Black Rate Marking † 21 = Red with No Rate Marking
 B = Black with White "Reset" Marked On Bezel (No Rate Marking) †

† Not available with Circuit Function "S".
 Consult factory for other bezel colors.

6. Button Color:

A = Black
 B = Red
 Consult factory for other button colors.

7. Amp Rating:

0.25†	1†	4	7	10	13	16
0.50†	2†	5	8	11	14	20*
0.75†	3	6	9	12	15	

† Not available with Circuit Function "S".
 * Contact factory for availability.

Outline Dimensions

Push-to-Reset Type

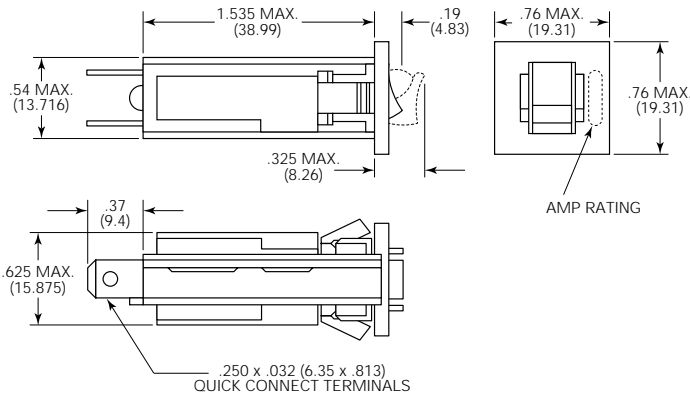

Switchable Type

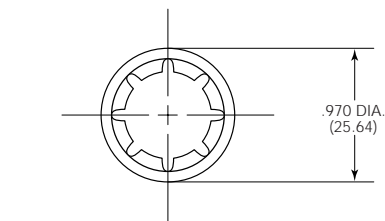
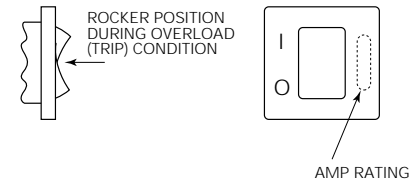

55-025B
 INTERNAL TOOTH
 PUSH-ON LOCKWASHER
 For panels greater than .105" (2.67) thickness

Recommended Panel Cutouts

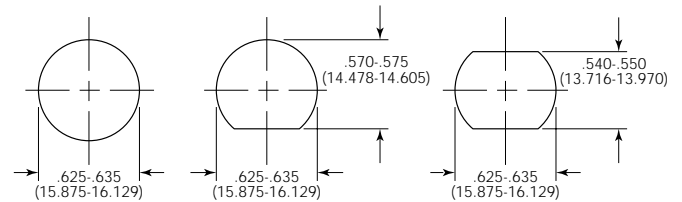

- Note:**
- Soldering to terminals is not recommended.
 - Recommended Panel Thickness: Style Q: .032" - .062" (.813 mm - 1.574 mm)
 Style T: .075" - .105" (1.905 mm - 2.667 mm)
 - Internal tooth push-on washer available for panel thickness not covered above. Part No. 55-025B.